



Katalog 2012 Laborglas



HAVAG Handels- und Vermittlungsagentur Glas GmbH
Gräfinauer Str. 3
98704 Wolfsberg OT Wümbach

Tel.: 036785/51090

Fax.: 036785/51099

e-mail: info@havag-glas.de

Internet: www.HAVAG-Glas.de

Aquarienkästen / Aquarium Jars

Rand geschliffen
Glasart Sodaglas

ground edge
material glass soda glass

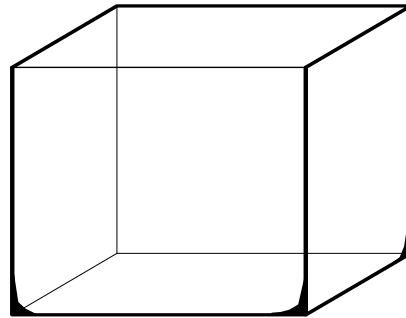

Höhe high	Länge length	Breite with	Bestellnummer order number
mm	mm	mm	
100	100	100	23 210 111
100	100	150	23 210 113
100	100	200	23 210 115
100	120	120	23 210 122
120	130	95	23 210 221
120	120	200	23 210 225
150	100	150	23 210 313
150	220	300	23 210 369
160	160	300	23 210 449
180	130	180	23 210 424
200	150	200	23 210 535
220	180	250	23 210 647
240	220	300	23 210 769
260	230	360	23 210 869

Batteriegläser / Cylinders

ohne Fuß, Rand geschliffen
Glasart Sodaglas

without base, fine ground edge
material glass soda glass



Durchmesser diameter mm	Höhe height mm	Bestellnummer order number
80	80	12 300 303
100	100	12 300 404
100	150	12 300 406
100	200	12 300 407
100	250	12 300 408
100	300	12 300 409
120	120	12 300 505
150	150	12 300 606
150	220	12 300 608
150	300	12 300 609
200	150	12 300 706
200	200	12 300 707
200	250	12 300 708
250	200	12 300 807
250	250	12 300 808

Zylinder mit Fuß / Jars with Foot

Rand verschmolzen
Glasart Sodaglas

fine ground edge
material glass soda glass

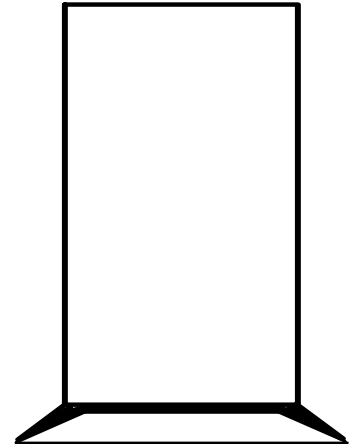

Durchmesser diameter mm	Höhe height mm	Bestellnummer order number
30	150	23 261 315
30	200	23 261 320
40	250	23 261 425
50	200	23 261 520
50	250	23 261 525
50	300	23 261 530
50	400	23 261 540
50	500	23 261 550

Dosen (Wattezylinder)
Jars for Cotton Wool

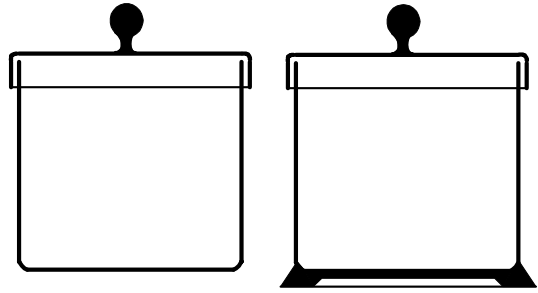

ohne Falz, mit überfallendem Knopfdeckel
 Rand geschliffen
 Glasart Sodaglas
 Typ 1 - Unterteil ohne Fuß
 Typ 2 - Unterteil mit Fuß
 Typ 3 - Knopfdeckel

without shoulder, with overlapping knobbed lid
 fine ground edge
 material glass soda glass
 type 1 - lower part without foot
 type 2 - lower part with foot
 type 3 - knobbed lid

Höhe height	Durchmesser diameter	Bestellnummer order number	Bestellnummer order number	Bestellnummer order number
mm	mm	Typ 1	Typ 2	Typ 3
80	80	12 300 303	23 143 529	23 143 424
100	100	12 300 404	23 143 532	23 143 427
120	120	12 300 505	23 143 535	23 143 430
150	150	12 300 606	23 143 538	23 143 433
150	200	12 300 706		23 143 434
200	200	12 300 707		23 143 434

Dosen / Jars

ohne Falz, mit überfallendem Deckel
Rand poliert
Glasart Sodaglas

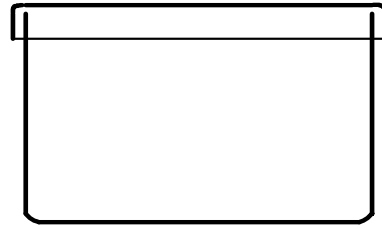

without shoulder, with overlapping lid
fine ground edge
material glass soda glass

Höhe heigth	Durchmesser diameter	Bestellnummer order number
mm	mm	Typ 1
70	240	23 143 309
100	200	23 143 308
130	240	23 143 310

Dosen / Jars

mit Falz, mit überfallendem Deckel
niedere Form
Glasart Sodaglas

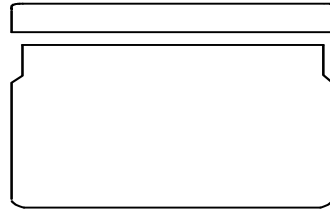

with shoulder and overlapping lid
low form
material glass soda glass

Höhe height	Durchmesser diameter	Bestellnummer order number
mm	mm	Typ 1
25	40	23 143 101
30	50	23 143 100
35	60	23 143 102
40	80	23 143 103
50	100	23 143 106
60	120	23 143 109
70	150	23 143 112

Steilbrustflaschen / Reagent Bottles

enghals, mit NS Schliff, ohne Stopfen

Typ A - Klarglas

Typ B - Braunglas

Glasart Sodaglas

narrow-necked, with standard ground socket (NS)

without stopper

typ A - clear glass

typ B - brown glass

material glass soda glass

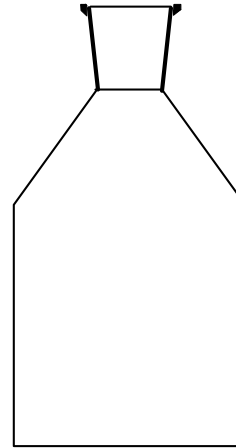

Nennvolumen volume	NS	Bestellnummer order number Typ A	Bestellnummer order number Typ B
ml			
50	14/15	23 231 103	23 231 303
100	14/23	23 231 104	23 231 304
250	19/26	23 231 105	23 231 305
500	24/29	23 231 106	23 231 306
1000	29/32	23 231 107	23 231 307
2000	29/32	23 231 108	23 231 308

Steilbrustflaschen / Reagent Bottles

weithals, mit NS Schliff, ohne Stopfen

Typ A - Klarglas

Typ B - Braunglas

Glasart Sodaglas

wide-necked, with standard ground socket (NS)

without stopper

typ A - clear glass

typ B - brown glass

material glass soda glass

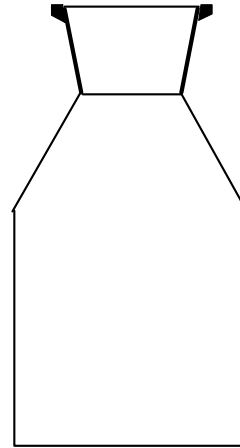

Nennvolumen volume	NS	Bestellnummer order number Typ A	Bestellnummer order number Typ B
ml			
50	24/20	23 231 503	23 231 703
100	29/22	23 231 504	23 231 704
250	34/24	23 231 505	23 231 705
500	45/27	23 231 506	23 231 706
1000	60/46	23 231 507	23 231 707
2000	60/46	23 231 508	23 231 708

Steilbrustflaschen / Reagent Bottles

enghals, mit NS Schliff, mit Glasstopfen

Typ A - Klarglas

Typ B - Braunglas

Glasart Sodaglas

narrow-necked, with standard ground socket (NS)

with glass stopper

typ A - clear glass

typ B - brown glass

material glass soda glass

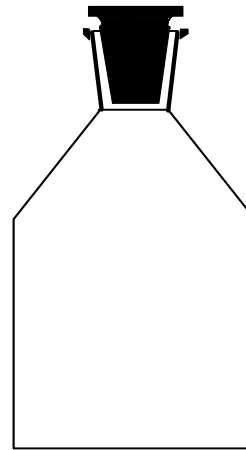

Nennvolumen volume	NS	Bestellnummer order number Typ A	Bestellnummer order number Typ B
ml			
50	14/15	23 231 203	23 231 403
100	14/23	23 231 204	23 231 404
250	19/26	23 231 205	23 231 405
500	24/29	23 231 206	23 231 406
1000	29/32	23 231 207	23 231 407
2000	29/32	23 231 208	23 231 408

Steilbrustflaschen / Reagent Bottles

weithals, mit NS Schliff, mit Glasstopfen

Typ A - Klarglas

Typ B - Braunglas

Glasart Sodaglas

wide-necked, with standard ground socket (NS)

with glass stopper

typ A - clear glass

typ B - brown glass

material glass soda glass

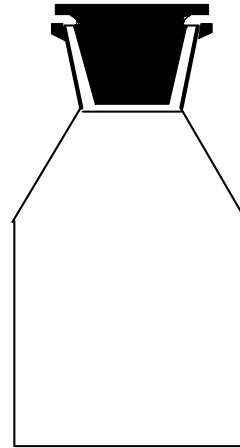

Nennvolumen volume	NS	Bestellnummer order number Typ A	Bestellnummer order number Typ B
ml			
50	24/20	23 231 603	23 231 803
100	29/22	23 231 604	23 231 804
250	34/24	23 231 605	23 231 805
500	45/27	23 231 606	23 231 806
1000	60/46	23 231 607	23 231 807
2000	60/46	23 231 608	23 231 808

Tropfgläser TK / Bottles dropping

mit eingeschliffenem Deckelstopfen

Typ A - Klarglas

Typ B - Braunglas

Glasart Sodaglas

with ground - in flat stopper

type A - clear glass

type B - brown glass

material glass soda glass



Nennvolumen volume ml	NS	Bestellnummer order number Typ A	Bestellnummer order number Typ B
50	14/23	23 232 202	23 232 402
100	14/23	23 232 204	23 232 404

Stopfen / Stoppers

achteckig



octagonal

Bestellnummer order number ml	NS	Typ type
23 422 104	14/15	massiv, klar
23 422 505	14/15	massiv, braun
23 422 105	14/23	massiv, klar
23 422 305	14/23	massiv, braun
23 422 106	19/26	massiv, klar
23 422 306	19/26	massiv, braun
23 422 407	24/20	massiv, klar
23 422 107	24/29	massiv, klar
23 422 307	24/29	massiv, braun
23 422 408	29/22	massiv, klar
23 422 508	29/22	massiv, braun
23 422 108	29/32	massiv, klar
23 422 308	29/32	massiv, braun
23 422 709	34/24	halbhohl, klar
23 422 909	34/24	halbhohl, braun
23 422 710	45/27	halbhohl, klar
23 422 810	45/27	halbhohl, braun
23 422 211	60/46	halbhohl, klar
23 422 311	60/46	halbhohl, braun

Bürettenflaschen **Reservoir Bottle for burettes**

mit Kegelschliffhülse NS 29/32, Bauhöhe 200 mm

Typ A - Klarglas

Typ B - Braunglas

Glasart Sodaglas

with standard ground socket NS 29/32, height 200 mm

typ A - clear glass

typ B - brown glass

material glass soda glass

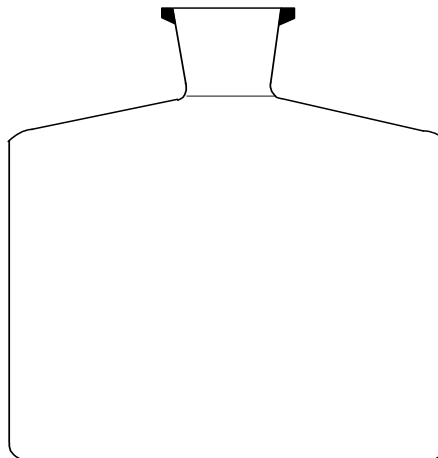

Nennvolumen volume	NS	Bestellnummer order number Typ A	Bestellnummer order number Typ B
ml			
20	29/32	23 231 953	23 231 952

Laborflaschen mit Gewinde Laboratory Bottles

mit blauer Schraubgewindekappe
 Glasart – Borosilikatglas
 Typ A – Klarglas
 Typ B – Braunglas

with blue screw cap
 material glass - borosilicate glass
 typ A – clear glass
 typ B – brown glass

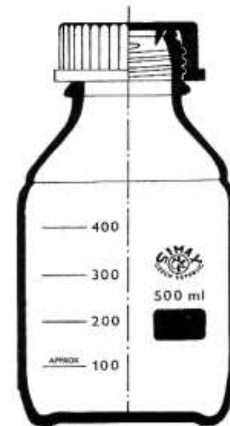

Nennvolumen volume	Bestellnummer order number Typ A	Bestellnummer order number Typ B
ml		
100	21 233 201	21 233 401
250	21 233 202	21 233 402
500	21 233 203	21 233 403
1000	21 233 204	21 233 404
2000	21 233 205	21 233 405
5000	21 233 206	21 233 406

Gaswaschflaschen
Gas Washing Bottles

nach Drechsel, Unterteil
Glasart – Borosilikatglas

typ Drechsel, lower part
material glass - borosilicate glass

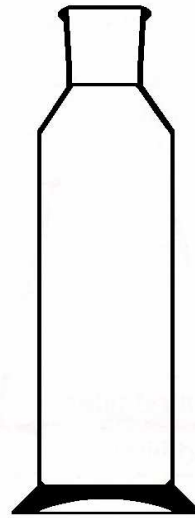

Nennvolumen volume	Bestellnummer order number
ml	
100	21 231 921
250	21 231 922
500	21 231 924

Färbekästen / Staining Troughs

Glasart Sodaglas
material glass soda glass

Typ type	Bestellnummer order number
Färbekasten nach Hellendahl mit Erweiterung, mit Deckel Staining trough type Hellendahl with wide upper section, with lid	23 253 111
Färbekasten nach Schiefferdecker, mit Deckel Staining trough type Schiefferdecker, with lid	23 253 201
Färbekasten nach Coplin, mit Deckel Staining trough type Coplin, with lid	23 253 401
Glaskasten für Färbegestell, mit Deckel Glass Jar for containing the staining tray, with lid	23 253 423
Färbegestell Staining tray	23 253 422
Glaskasten mit Färbegestell und Deckel, komplett Glass Jar with Staining tray and lid, complete	23 253 424
Färbekasten nach Hellendahl ohne Erweiterung, mit Deckel Staining trough type Hellendahl without wide upper section, with lid	23 253 101

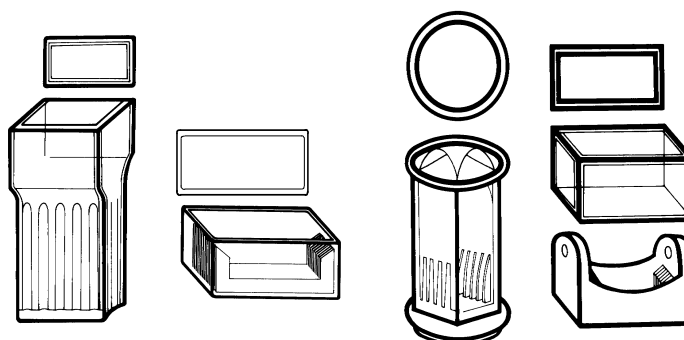

Färbezylinder / Staining Jars

mit überfallendem Deckel
Glasart Sodaglas

with overlapping cover
material glass soda glass

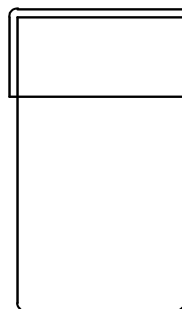

Höhe height	Durchmesser diameter	Länge length	Breite width	Typ typ	Bestellnummer order number
mm	mm	mm	mm		
85	40	-	-	rund	23 262 101
85	-	20	40	oval	23 262 201
85	-	20	40	eckig	23 262 301

Mikroskopiernäpfe

mit Deckscheibe
Typ A - klar
Typ B - schwarz

with cover
type A – clear
type B – black

Abmessung dimension	Bestellnummer order number Typ A	Bestellnummer order number Typ B
mm	mm	
40 x 40	23 253 425	23 253 426

Uhrglasschalen
Watch Dishes

Rand verschmolzen
Glasart Sodaglas

with fused edges
material glass soda glass

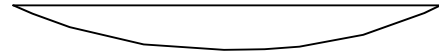

Durchmesser diameter	Bestellnummer order number
mm	
40	23 129 904
50	23 129 905
60	23 129 906
70	23 129 907
80	23 129 908
90	23 129 909
100	23 129 910
110	23 129 911
120	23 129 912
125	23 129 913
140	23 129 915
150	23 129 916

Petrischalen / Petri dishes

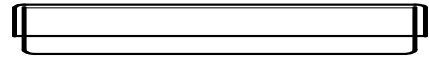

Anumbra
Glasart Sodaglas

Anumbra
material glass soda glass

Durchmesser diameter	Höhe height	Bestellnummer order number
mm	mm	
40	12	23 123 600
50	12	23 123 601
60	12	23 123 602
60	15	23 123 612
70	15	23 123 604
80	15	23 123 603
90	15	23 123 605
100	10	23 123 608
100	15	23 123 607
100	20	23 123 606
120	20	23 123 609
150	25	23 123 611
180	30	23 123 615
200	30	23 123 610
200	50	23 123 613

Trichter / Funnels

mit kurzem Stiel

Typ 1 - Sodaglas

Typ 2 - Borosilikatglas

with short stem

type 1 - soda glass

type 2 - borosilicate glass

di - Stielinnendurchmesser, internat diameter of stem

l - Stiellänge, length of stem

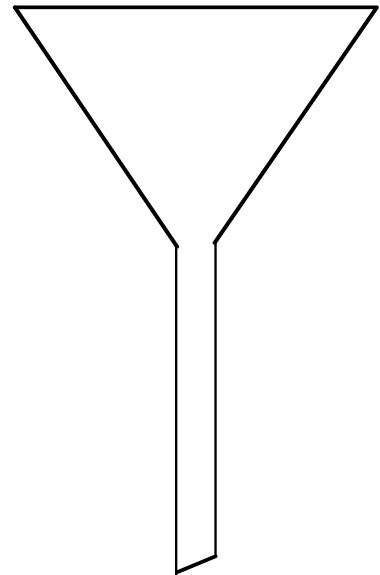

Trichter- durchmesser diameter of the funnel mm	di mm	l mm	Bestellnummer Typ 1 order number type 1	Bestellnummer Typ 2 order number type 2
30	3	30	23 161 100	23 161 200
35	3	35	23 161 101	23 161 201
40	3	40	23 161 102	23 161 202
45	3	45	23 161 103	23 161 203
50	5	50	23 161 104	23 161 204
55	5	55	23 161 105	23 161 205
60	5	60	23 161 106	23 161 206
70	5	70	23 161 107	23 161 207
75	5	75	23 161 117	23 161 217
80	6	80	23 161 108	23 161 208
100	6	100	23 161 109	23 161 209
125	6	120	23 161 110	23 161 210
150	12	150	23 161 112	23 161 212

Pulvertrichter / Powder Funnels

Glasart Borosilikatglas 3.3

material glass borosilicate glass 3.3

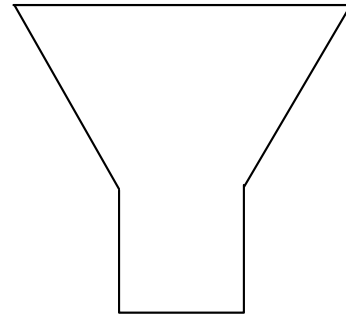

Trichter- durchmesser diameter of the funnel mm	Stielaußen- durchmesser external diameter of the stem mm	Bestellnummer order number
50	20	23 163 101
60	22	23 163 102
70	22	23 163 103
80	28	23 163 104
100	34	23 163 105
120	34	23 163 106

Präparatekästen / Specimen Jars

Kastenform, mit Abdeckscheibe
Sodaglas

box-type, with cover disk
material glass soda glass

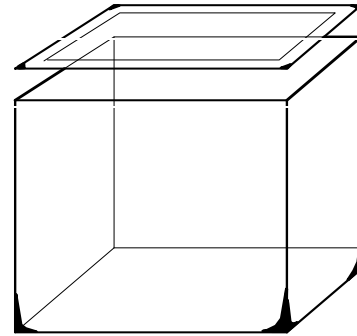

Kasten Unterteil
Jar

Deckscheibe
Cover Disk

Höhe high	Länge length	Breite with	Bestellnummer order number	Länge length	Breite With	Bestellnummer order number
mm	mm	mm		mm	mm	
100	50	50	23 252 309	50	50	23 253 009
100	80	60	23 252 322	80	60	23 253 022
150	105	50	23 252 631	105	50	23 253 031
150	80	60	23 252 621	80	60	23 253 021
200	130	80	23 252 952	130	80	23 253 052
120	105	50	23 252 421	105	50	23 253 031
150	100	100	23 252 633	100	100	23 253 033
200	100	100	23 210 511	100	100	23 253 033
200	130	130	23 252 955	130	130	23 253 055
225	200	100	23 252 983	200	100	23 253 083

Meßzylinder
Measuring Cylinder

hohe Form, Glasfuß sechskant, ungraduiert
Glasart – Borosilikatglas

tall form, glass base, without graduation
material glass - borosilicate glass

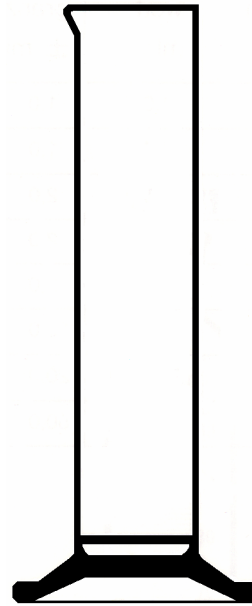

Nennvolumen volume	Bestellnummer order number
ml	
25	21 321 203 01
50	21 321 204 01
100	21 321 205 01
250	21 321 206 01
500	21 321 207 01
1000	21 321 208 01
2000	21 321 209 01

Wägegläser
Weighing bottles

hohe und niedere Form,
mit eingeschliffenem Deckel
Glasart – Borosilikatglas

tall and low form,
with ground-in cover
material glass - borosilicate glass

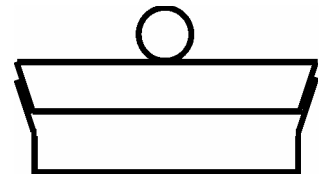
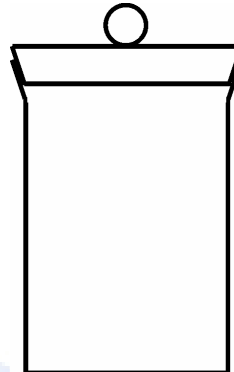

Durchmesser diameter	Höhe heigh	Bestellnummer order number
mm	mm	
25	30	23 135 102
35	30	23 135 106
40	30	23 135 109
50	30	23 135 111
60	30	23 135 113
80	30	23 135 116
25	40	23 135 103
30	50	23 135 105
35	60	23 135 107
40	80	23 135 110

Hahnküken Stopcock Key

massiv, austauschbar, nach DIN 12541
Glasart – Borosilikatglas

solid, interchangeable, according to DIN 12541
material glass - borosilicate glass



NS NS	Bohrung bore mm	Bestellnummer order number
12,5	1,5	23 425 101
12,5	2,5	23 425 111
14,5	2,5	23 425 102
14,5	4,0	23 425 112
14,5	1,5	23 425 122
19	4	23 425 103
19	6	23 425 131

Kugelschliffe

Spherical cones

nach DIN
Glasart – Borosilikatglas



according to DIN

material glass - borosilicate glass

Schliffgröße size	Schale/Kugel cup/ball	Bestellnummer order number
13/2	Schale cup	21 702 101
13/5	Schale cup	21 702 102
19/7	Schale cup	21 702 103
19/9	Schale cup	21 702 104
19/10	Schale cup	21 702 105
29/12	Schale cup	21 702 106
29/15	Schale cup	21 702 107
35/20	Schale cup	21 702 108
35/25	Schale cup	21 702 109
40/25	Schale cup	21 702 110
41/25	Schale cup	21 702 111
50/30	Schale cup	21 702 112
64/40	Schale cup	21 702 113
13/2	Kugel ball	21 703 101
13/5	Kugel ball	21 703 102
19/7	Kugel ball	21 703 103
19/9	Kugel ball	21 703 104
19/10	Kugel ball	21 703 105
29/12	Kugel ball	21 703 106
29/15	Kugel ball	21 703 107
35/20	Kugel ball	21 703 108
35/25	Kugel ball	21 703 109
40/25	Kugel ball	21 703 110
41/25	Kugel ball	21 703 111
50/30	Kugel ball	21 703 112
64/40	Kugel ball	21 703 113

Sondergrößen auf Anfrage